

Commercial electric water heaters

1024 MODELS

80 imperial gallons / 364 litres

Model	Storage Capacity		Input (kW)	Voltage (Volts)	Ph.	Dimensions inches (cm)		Weight lb (kg)
	Imp. gal	Litres				H	D	
1024	80	364	6 to 12	208	1	55 3/8 (141)	28 1/4 (72)	380 (172)
1024	80	364	6 to 12	240	1	55 3/8 (141)	28 1/4 (72)	380 (172)

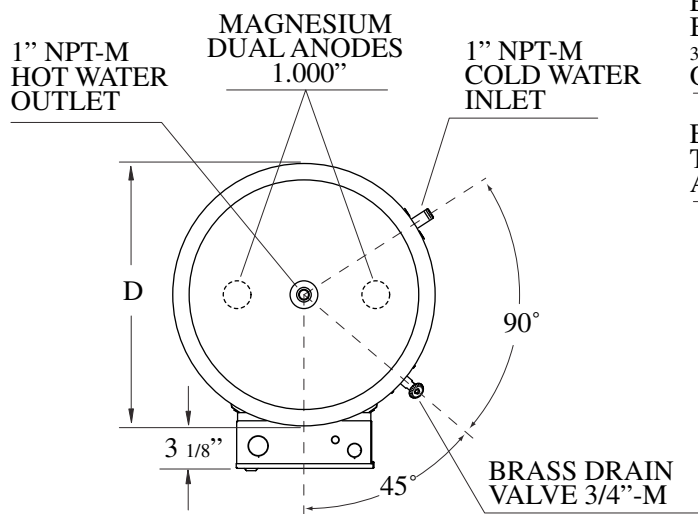

ELECTRICAL BOX WITH 3/4" to 1 1/4" OPENINGS

ELEMENTS AND THERMOSTATS ACCESS DOOR

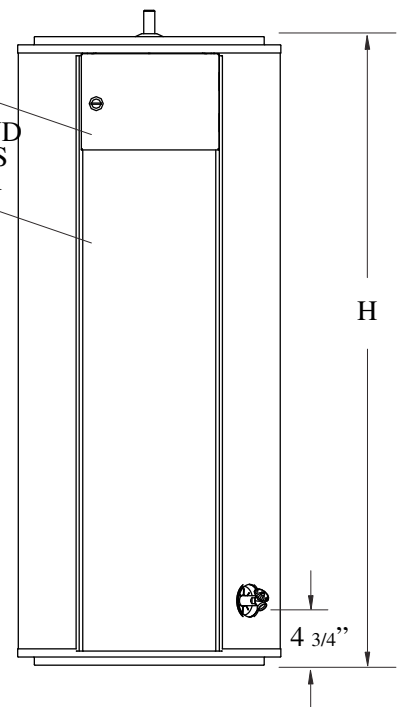

JOB TITLE _____

ADDRESS _____

CONTRACTOR _____

ADDRESS _____

ENGINEER _____

SUBMITTED DATE _____

REQUIRED PRODUCT _____

MODEL NO. _____ SIZE _____ QUANTITY _____

MODEL NO. _____ SIZE _____ QUANTITY _____

MODEL NO. _____ SIZE _____ QUANTITY _____

MODEL NO. _____ SIZE _____ QUANTITY _____

REQUIRED DATE _____

In accordance with our product continued improvement policy, Giant Factories Inc. reserves the right to make changes or improvements at any time without prior notice.

giantinc.com