

Commercial electric water heaters

1123 MODELS

100 imperial gallons / 455 litres

Model	Storage Capacity		Input (kW)	Voltage (Volts)	Ph.	Dimensions inches (cm)		Weight lb (kg)
	Imp. gal	Litres				H	D	
1123	100	455	9 to 18	208	1-3	67 $\frac{3}{8}$ (171)	28 $\frac{1}{4}$ (72)	423 (192)
1123	100	455	9 to 18	240	1-3	67 $\frac{3}{8}$ (171)	28 $\frac{1}{4}$ (72)	423 (192)
1123	100	455	9 to 18	600	3	67 $\frac{3}{8}$ (171)	28 $\frac{1}{4}$ (72)	423 (192)

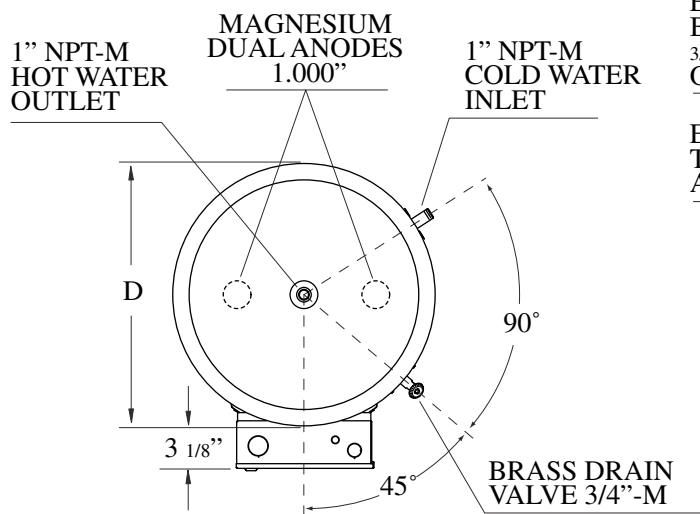

ELECTRICAL BOX WITH 3/4" to 1 1/4" OPENINGS

ELEMENTS AND THERMOSTATS ACCESS DOOR

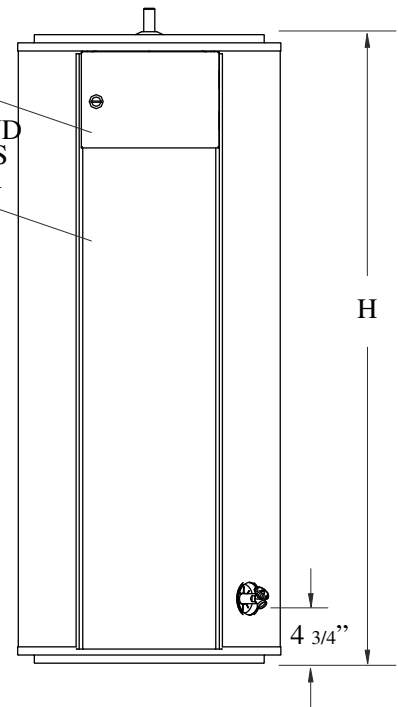

JOB TITLE

ADDRESS

CONTRACTOR

ADDRESS

ENGINEER

SUBMITTED DATE

REQUIRED PRODUCT

MODEL NO. SIZE QUANTITY

MODEL NO. SIZE QUANTITY

MODEL NO. SIZE QUANTITY

MODEL NO. SIZE QUANTITY

REQUIRED DATE

In accordance with our product continued improvement policy, Giant Factories Inc. reserves the right to make changes or improvements at any time without prior notice.

giantinc.com