

COMMERCIAL ELECTRIC WATER HEATER OWNER'S MANUAL OPERATION AND MAINTENANCE INSTRUCTIONS

DANGER

Make sure to follow the instructions mentioned in this manual in order to reduce the risk of fire, explosion, property damage, personal injury, or death.

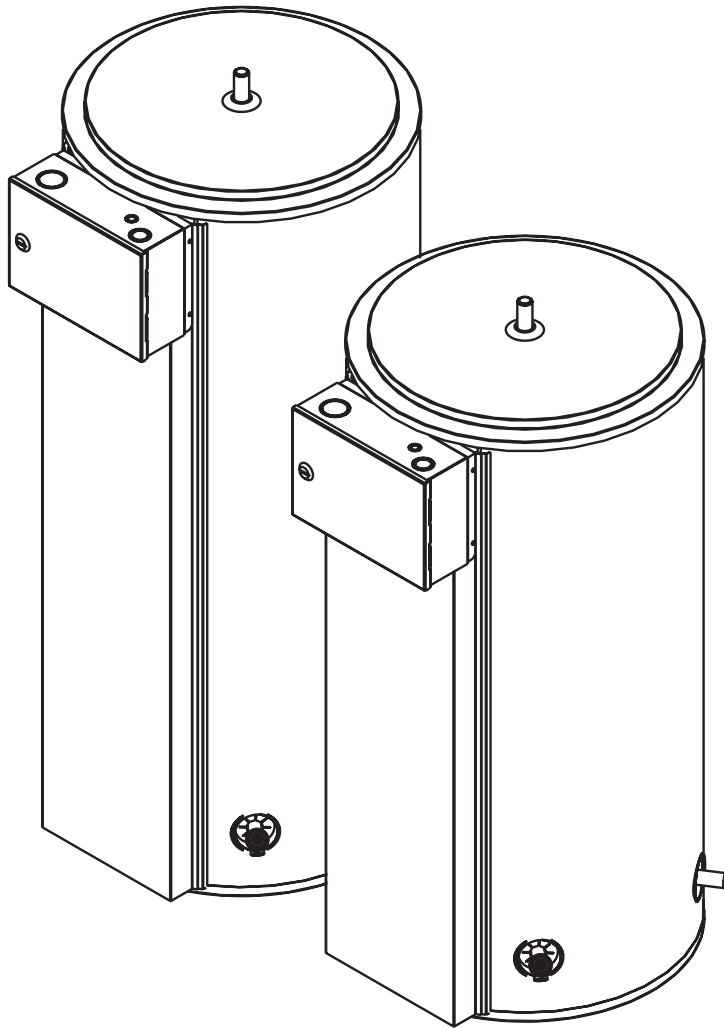

- **DO NOT REMOVE** the element and thermostat access panel before the power to the water heater is turned “**OFF**”.
- **DO NOT ATTEMPT** to repair or replace any of the electrical components installed on the water heater before the power to the water heater is turned “**OFF**”.
- **DO NOT USE** the water heater on a voltage other than the one specified on the water heater rating plate.
- **DO NOT CONNECT** the power supply wiring anywhere else but the main power connection on the water heater.
- **DO NOT TURN THE POWER ON** to the water heater unless it is completely filled with water.
- **DO NOT DRAIN** the water heater unless the power to the water heater is turned “**OFF**”.
- **DO NOT STORE** or use gasoline or other flammable vapours and liquids in the vicinity of this appliance.

WHAT TO DO IF YOU SMELL SMOKE

- Immediately turn the power “**OFF**” to the water heater.
- If smoke remains, call your local fire department.
- When smoke has disappeared, call a qualified service technician to identify the problem and perform required repairs.

IMPORTANT

READ THESE INSTRUCTIONS CAREFULLY BEFORE BEGINNING THE INSTALLATION PROCESS. PROPER INSTALLATION WILL PROVIDE SAFE AND EFFICIENT SERVICE, AND AVOID NEEDLESS EXPENSE THAT ARE UNCOVERED BY THE WARRANTY. READ THE PRODUCT WARRANTY CONTAINED IN THIS MANUAL AND REMEMBER TO FILL OUT AND RETURN TO THE MANUFACTURER THE RELEVANT WARRANTY CARD AND CERTIFICATES, IF REQUIRED. SHOULD YOU HAVE ANY QUESTIONS, PLEASE CONTACT YOUR LOCAL DEALER OR REFER TO THE *GETTING SERVICE FOR YOUR WATER HEATER* SECTION OF THIS MANUAL. SAVE THIS MANUAL FOR FUTURE REFERENCES.

For your records, write the model and serial number here:

Model # : _____

Serial # : _____



TABLE OF CONTENTS

Safety Information	2	General Maintenance	5
Installation Instructions	3	Condensation	5
Temperature & Pressure-Relief Valve.....	3	Water Heater Tank.....	5
Pressure Build-up in a Water System	3	Element or Thermostat Replacement.....	5
Filling the Water Heater	3	Temperature and Pressure-Relief Valve.....	5
Electrical Connections.....	3	Anodes.....	5
Operating Instructions.....	4	Draining the Water Heater	6
Starting the Water Heater.....	4	Vacation	6
Start-up Procedure.....	4	Getting Service for your Water Heater	6
Safety Controls.....	4	Troubleshooting Guide.....	7
Water Temperature Regulation.....	4		

SAFETY INFORMATION

Your safety and the safety of others is extremely important during the installation, operation, and servicing of this water heater. Many safety-related messages have been provided in this manual. Always read and follow all safety messages since they will point out the potential hazard, tell you how to reduce the risk of injury, and tell you what will happen if the instructions are not followed.



This is the safety alert symbol. This symbol alerts you from potential hazards that can kill or hurt you as well as others. All safety messages will follow the safety alert symbol and either the word “DANGER” or “WARNING”.

 DANGER	Serious injury or death can occur if you do not immediately follow the instructions.
---	--

 WARNING	Serious injury or death can occur if you do not follow the instructions.
--	--

 WARNING
DO NOT use this water heater if any part has been under water. Immediately call a qualified service technician to inspect the water heater and to replace any part of the control system which has been under water. Failure to follow this instruction can result in property damage, personal injury, or death.

IMPORTANT

These instructions have been written as a guide for the proper operation of your water heater, and the manufacturer of this water heater will not accept any liability where these instructions have not been followed. However, for your safety and to avoid damage caused by improper installation, this water heater must be installed by a Certified Licensed Professional, and meet with all local codes or, in the absence of local codes, CSA C22.1 Canadian Electrical Code, in Canada, and/or the National Electrical Code, ANSI/NFPA 70, in the United States.

INSTALLATION INSTRUCTIONS

Temperature and Pressure-Relief Valve

WARNING

DO NOT plug the temperature and pressure-relief valve or its discharge line. DO NOT remove the relief valve. Make sure the relief valve is properly sized for the water heater. If the relief valve continuously discharges water, call a qualified service technician to correct the problem. Failure to follow these instructions can result in property damage, personal injury, or death.

To protect from excessive pressure and/or temperature, a temperature and pressure-relief valve that meets with the requirements of the Standard for Relief Valves and Automatic Gas Shut-Off Devices for Hot Water Supply Systems, CSA 4.4, in Canada, and ANSI Z21.22, in the United States **MUST BE** installed by the installer if it has not been factory installed. The relief valve should have a maximum set pressure that does not exceed the hydrostatic working pressure of the water heater (150 psi = 1,035 kPa) and a BTU/h rating equal to or greater than the input rating, as shown on the water heater rating plate. It should never be plugged or removed from the opening marked for it on the water heater.

If this relief valve needs to be replaced, use only a new temperature and pressure-relief valve. Never install an old or existing relief valve, as it may be damaged or inadequate for the working requirements of the new water heater. This new relief valve must meet with all local codes or, at a minimum, the above-mentioned requirements. Never install another valve between the relief valve and the water heater.

A discharge line must be installed into the relief valve. The discharge line:

- Must not be smaller than the outlet pipe size of the relief valve.
- Must not terminate less than six (6) inches (15.2 cm) and not more than twelve (12) inches (30.5 cm) above the floor drain.
- Must not be restricted in any way. Do not thread, cap, or in any way restrict the end of this outlet.
- Must be made of a material able to withstand 210°F (99°C) without distortion.
- Must be installed to allow complete drainage of the relief valve and discharge line.
- Must terminate at an adequate free-flowing drain.

Pressure Build-up in a Water System

When the water heater operates, the heated water expands creating a pressure build-up. This is a natural function and is one of the reasons for installing a temperature and pressure relief valve. If the cold water supply line has a built-in water meter, check valve, or pressure-reducing valve, a suitable expansion tank must be installed to prevent pressure build-up or water hammer effect; otherwise the warranty will be void. An indication of pressure build-up translates into frequent discharges of water from the relief valve. If the relief valve discharges water on a continuous

basis, it may indicate a malfunction of the relief valve, and a qualified service technician must be called to have the system checked, and the problem corrected.

Filling the Water Heater

WARNING

NEVER operate the water heater unless it is completely filled with water. Failure to follow this instruction can result in premature failure of the water heater and its component parts and will not be covered by the warranty.

Check that all the water piping connections have been made. To fill the water heater:

- 1) Make sure that the water heater drain valve is closed by turning the knob clockwise .
- 2) Open the cold water supply manual shut-off valve. This valve must remain open, as long as the water heater is in use. **NEVER** operate the water heater with the cold water supply manual shut-off valve closed.
- 3) To make sure the water heater is completely filled with water, open all of the hot water faucets to let the air out of the water heater and plumbing system. Leave the faucets open until a constant flow of water is obtained.
- 4) Check all of the plumbing connections to make sure there are no leaks.

Electrical Connections

WARNING

This water heater uses an external electrical source for power. It must be electrically grounded in accordance with all local codes or, in the absence of local codes, CSA C22.1 Canadian Electrical Code in Canada and/or the National Electrical Code ANSI/NFPA 70 in the United States. Failure to properly ground this water heater can result in property damage, personal injury, or death.

This water heater must be connected on a separate fuse branch circuit. Check the water heater rating plate for the element wattage and voltage and make sure that the power supply wiring and the fusing or circuit breaker are the correct size for this water heater. Verify that all the wire connections on the element and thermostat have been installed correctly, are secure, and that none of the wires are grounded, have split, or are broken.

If any of the original wiring needs replacing, use only 14AWG-type, or greater wire that is approved for 221°F (105°C).

OPERATING INSTRUCTIONS



Starting the Water Heater

Before turning the power on to your water heater, make sure that you have read and understood all the instructions and warnings in this manual and on your water heater. Should you have any questions about turning on your water heater, immediately contact a qualified installer, service agency, or the local electric utility.

⚠ WARNING

DO NOT turn the power “**ON**” to this water heater if:

- It is not completely filled with water.
- The power supply voltage does not match the voltage listed on the rating plate.
- Gasoline or other flammable vapours and liquids have been stored in the vicinity of the water heater.

Failure to follow these instructions can result in property damage, personal injury, or death.

⚠ DANGER

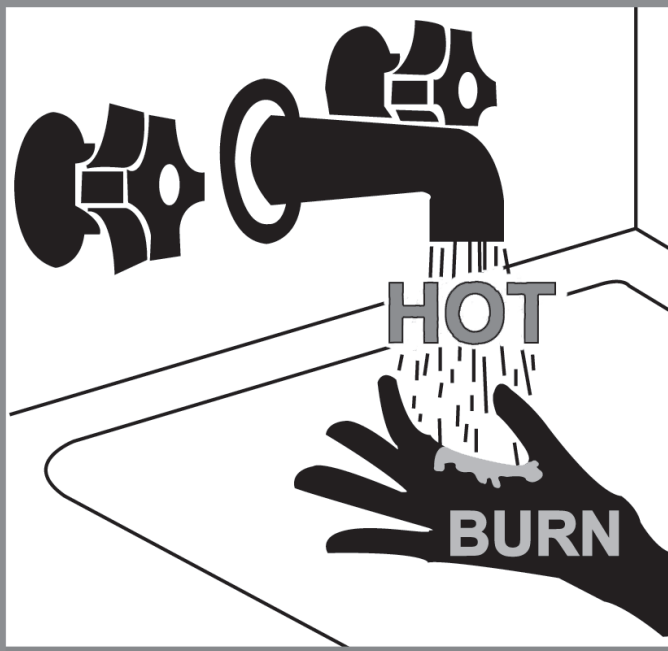

Start-up Procedure

- 1) Turn the circuit breaker on at the main service panel.
- 2) Make sure the fuse box or power switch (if any) next to the water heater is pushed to “**ON**”.
- 3) If you smell smoke, refer to the “**what to do if you smell smoke**” warning.
- 4) Wait for one (1) hour. At this time, hot water should be available at the faucet.

- 5) If after the one (1)-hour wait you do not get any hot water, check that the fuse or circuit breaker is in working condition.
- 6) Wait one (1) more hour. If there is no hot water at this point, call a qualified service technician.

Note: If after the one (1)-hour wait you receive only a small quantity of hot water, check that the plumbing connections are not reversed.

Safety Controls

This water heater is equipped with a combination thermostat and high limit reset control (ECO). If for any reason the temperature of the water becomes excessively high, the ECO will interrupt the power circuit to the heating element. Once the control opens, it must be reset manually.

To reset the ECO:

- 1) Turn the power “**OFF**” to the water heater.
- 2) Remove the upper element and thermostat access panel and the insulation.
- 3) Press the red “**RESET**” button.
- 4) Replace the insulation and the element and thermostat access panel before turning the power “**ON**” to the water heater.

Water Temperature Regulation

⚠ WARNING

The higher is the setting, the greater the risk of scalding. Hot water can cause third degree burns in under one (1) second at 160°F (71°C), in five (5) seconds at 140°F (60°C), and in thirty (30) seconds at 130°F (54°C). In places where there are children, physically challenged individuals, or elderly persons, mixing valves for point of use are necessary in order to decrease the scalding potential of hot water.

The thermostat is factory set at 140°F (60°C) for Canadian models and 125°F (52°C) for US models. To adjust the temperature on the thermostat:

- 1) Turn the power “**OFF**” to the water heater.
- 2) Remove the element and thermostat access panel and the insulation. On US models, **DO NOT** remove the thermostat protective cover.
- 3) Using a small flathead screwdriver, turn the thermostat dial to the desired temperature.
- 4) Replace the insulation and the element and thermostat access panel before turning the power “**ON**” to the water heater.

GENERAL MAINTENANCE

Housekeeping Condensation

Condensation can form on the surface of the water heater:

- 1) When the water heater is filled with cold water for the first time.
- 2) If the water heater has been undersized.
- 3) When large amounts of hot water are drawn from the water heater in a short period of time, and the refill water is very cold.

Due to the high efficiency rating of this electric water heater, it may produce more condensation than older models. This condition is common and must never be interpreted as a leaking tank. It will disappear once the water is heated.

Because of the large amounts of water that can condense, it is very important that a drain pan must be installed under the water heater. **Under no circumstances will the manufacturer be held liable for any water damage, in connection with the water heater.** If the problem remains and water continues to drip after the water heater has heated up, check all of the plumbing connections to make sure they are not leaking.

Water Heater Tank

Drain a pail of water through the drain valve at least once a year. This will remove excess sediment from the bottom of the tank. This sediment, if allowed to accumulate, will reduce the efficiency and the life of the tank.

Element and Thermostat Replacement

WARNING

Before attempting to repair or replace any of the electrical components on this water heater, turn the power **“OFF”** to the water heater. Failure to do so could result in property damage, personal injury, or death.

Replacing an Element

- 1) Turn the power **“OFF”** to the water heater and drain all of the water from the water heater (see Draining the Water Heater).
- 2) Remove the element and thermostat access panel and the insulation.
- 3) Disconnect the wires from the element.
- 4) For a square flange element, undo the four (4) bolts securing the element to the water heater.
- 5) Replace the element with a new element of the same wattage and voltage. Make sure that the gasket surface is clean and that the element has been re-installed and is water-tight.
- 6) Re-connect the wiring and tighten securely.

- 7) Re-fill the water heater (see Filling the Water Heater). **DO NOT TURN THE POWER ON TO THE WATER HEATER UNLESS YOU ARE SURE IT IS COMPLETELY FILLED WITH WATER.**

- 8) Replace the insulation

Replacing a Thermostat

- 1) Turn the power **“OFF”** to the water heater.
- 2) Remove the element and thermostat access panel and the insulation.
- 3) Disconnect the wires from the thermostat.
- 4) Lift the thermostat bracket arms and slide the thermostat up.
- 5) Replace the thermostat with a new thermostat of the same manufacturer and type.
- 6) Reconnect and tight the wires on the thermostat.
- 7) Set the thermostat to the desired temperature (see **Water Temperature Regulation**).
- 8) Replace the insulation and element and the thermostat access panel before turning the power **“ON”** to the water heater.

Temperature and Pressure-Relief Valve

Manually operate the temperature and pressure-relief valve at least once a year, standing clear of the outlet to avoid being burned. Lift and release the operating lever on the valve to make it operate freely. If, after manually operating the valve, it fails to completely reset and continues to discharge water, replace it with a new one.

Anodes

This water heater is equipped with two magnesium anodes that are designed to prolong the life of the water heater. The anodes are slowly consumed, protecting the glass-lined tank from corrosion. The anodes should be inspected every two (2) years. If more than half of the anodes has been consumed, they should be replaced. Instructions on how to change the anodes can be obtained from the manufacturer.

The life expectancy of the water heater is reduced when a water softener is introduced to fight hard water. Sodium salts added by a softener make the water extremely conductive; therefore, the anodes are consumed more rapidly. Under these conditions, the anodes should be inspected every year.

In certain water conditions, the anodes will react with the water, producing discoloured or smelly water. The most common complaint is hot water that smells like rotten eggs. This phenomenon is the result of the reaction between the anode and hydrogen sulphide gas dissolved in the water, which occurs frequently in well systems. This problem can usually be eliminated or reduced by changing the magnesium anodes to aluminum anodes and by chlorinating the water heater and plumbing system. If the problem persists, special filtration equipment may be required. Under no circumstances are the anodes to be removed from the water heater on a permanent basis. **Removal of the anodes will lead to premature failure of the water heater and will void the warranty.**

GENERAL MAINTENANCE

WARNING

Hydrogen gas can be produced in a hot water system that has not been used for a long period of time (generally two (2) weeks or more). **HYDROGEN GAS IS EXTREMELY FLAMMABLE.** It is highly recommended to open the hot water faucet for several minutes before you use any electrical appliances connected to the hot water system, such as a dishwasher or washing machine. If hydrogen gas is present, there will be an unusual sound, such as air escaping through the pipe, as the hot water faucet is opened. **DO NOT** smoke or introduce an open flame near the faucet when it is opened.

Draining the Water Heater

To completely drain the water heater:

- 1) Turn the power “**OFF**” to the water heater.
- 2) Close the cold water supply manual shut-off valve.
- 3) Connect one end of a garden hose to the water heater drain valve and put the other end next to a free-flowing drain.
- 4) Open the drain valve by turning the knob counter clockwise .
- 5) Open a hot water faucet to allow air into the system.

Vacation

If you are planning a vacation or a prolonged absence, it is highly recommended to turn the power “**OFF**” to the water heater as well as the cold water supply. This will save energy, protect against property damage in the event the water heater leaks, and prevent the build-up of hydrogen gas. If the water heater and piping are exposed to freezing temperatures, they should both be drained. Remember to check the water heater thoroughly after it has been shut off for an extended period of time before putting it back in operation. Make sure that the water heater is completely filled with water, and that the cold water supply manual shut-off valve is open, before turning the power “**ON**” to the water heater.

Getting Service for your Water Heater

If you are experiencing problems with your water heater, follow these three easy steps:

- 1) Read the **Troubleshooting Guide** contained in this manual. It states the most common problems experienced with your electric water heater. The solutions you find listed may provide a quick and simple solution to your problem and save you time and money.
- 2) If the solution listed in the guide does not solve the problem, contact the installer of the water heater, or the local electric utility.
- 3) If you still cannot solve the problem, contact the manufacturer’s Customer Service Department by e-mail at service@giantinc.com or call at **1-800-363-9354**. To help serve you in a quick and efficient way, **always have the following information handy:**
 - a) **Model number**
 - b) **Serial number**
 - c) **Date of installation**
 - d) **Manufacturer’s name**
 - e) **Complete address where the water heater is installed**
 - f) **A description of the problem.**

TROUBLESHOOTING GUIDE

CONDITION	CAUSE	REMEDY
No hot water.	Main power supply is "OFF".	Turn the main power supply "ON".
	Dry-fired element.	Replace with new element.
	Burnt fuse.	Replace with new fuse.
	Circuit breaker has tripped.	Reset circuit breaker.
	High limit reset control has tripped.	Reset high limit control by pushing the red reset button.
	Circuit breaker is defective.	Replace with new circuit breaker.
	Defective thermostat.	Replace with new thermostat.
	Defective element.	Replace with new element.
Not enough hot water.	Water heater is undersized.	Install size of water heater that meets demand.
	High hot water demand.	Increase the temperature of the thermostat.
	Very cold water supply.	Increase the temperature of the thermostat.
	Wrong piping connections.	Correct piping.
	Sediment or lime accumulation at bottom of water heater.	Drain water heater. Check to see if water treatment is necessary.
	Hot water plumbing system leaks.	Check hot water plumbing system for leaks and repair.
	Thermostat adjusted too low.	Increase the temperature of the thermostat.
	Defective thermostat.	Replace with new thermostat.
	Defective element.	Replace with new element. In 90% of all cases, it is the bottom element.
	Long runs or exposed piping.	Insulate piping.
	Hot water piping on outside wall.	Insulate piping.
Defective dip-tube.	Replace with new dip-tube.	
Boiling hot water.	Thermostat temperature set too high.	Lower the temperature on the thermostat.
	Thermostat not in contact with water heater.	Position properly. Be sure insulation is not interfering with thermostat.
	Element attacked by CO ² .	Replace with new element.
	Defective thermostat.	Replace with new thermostat.
Continuous operation.	Water heater is undersized.	Install size of water heater that meets demand.
	Element wattage too small.	Replace with higher element wattage.
	Thermostat not in contact with water heater.	Position properly. Be sure insulation is not interfering with thermostat.
	Thermostat temperature set too low.	Increase the temperature of the thermostat.
	Defective thermostat.	Replace with new thermostat.
Defective high limit reset control.	Replace with new high limit reset control.	
Element failure.	Wiring connections are wrong.	See the installation manual for correct wiring.
	Wiring connections are loose.	Locate, clean carefully, reconnect properly.
	Lightning/Power surge.	Inspect/replace fuse, element, and thermostat.
	High voltage.	Check with electrical utility and correct.
	Short circuit.	Locate short circuit and repair.
Thermostat failure.	No power.	Inspect fuse/circuit breaker, replace/reset.
	Loose wiring connection.	Locate, clean carefully, reconnect properly.
	Lightning/Power surge.	Inspect/replace fuse, element, and thermostat.
	Low/High voltage.	Check with electrical utility and correct.
	Short circuit.	Locate short circuit and repair.
Blown fuse/circuit breaker.	Wiring connections are wrong.	See the installation manual for correct wiring.
	Wiring connections are loose.	Locate, clean carefully, reconnect properly.
	Lightning/Power surge.	Inspect/replace fuse, element, and thermostat.
	High voltage.	Check with electrical utility and correct.
	Short circuit.	Locate short circuit and repair.
	Power supply wiring undersized.	See the installation manual for correct wiring size.

TROUBLESHOOTING GUIDE

CONDITION	CAUSE	REMEDY
Fuse burns instantly.	Short circuit.	Locate short circuit and repair.
Fuse burns often.	Fuse contacts oxidized or fuse not screwed-in tight enough.	Clean contacts and tighten fuse.
	Power supply wiring is undersized.	See the installation manual for correct wiring size.
Smoking wiring.	Lightning/Power surge.	Inspect/replace fuse, element, and thermostat.
	Low/High voltage.	Check with electrical utility and correct.
	Power supply wiring undersized.	See the installation manual for correct wiring size.
Service wires charred or hot.	Wiring connections are wrong.	See the installation manual for correct wiring.
	Water heater not properly grounded.	Properly ground the water heater.
	Lightning/Power surge.	Inspect/replace fuse, element, and thermostat.
	High voltage.	Check with electrical utility and correct.
	Short circuit.	Locate short circuit and repair.
	Power supply wiring undersized.	See the installation manual for correct wiring size.
Drain valve leaks.	Drain valve is open.	Close the drain valve.
	Defective drain valve.	Replace with new drain valve.
Water drips from the relief valve.	Excessive water pressure.	Install a pressure-reducing valve.
	Thermal expansion in a closed water system.	Install a suitable expansion tank on the cold water supply line.
	Improperly seated relief valve.	Check relief valve works properly and replace, if necessary.
	Defective thermostat.	Replace with new thermostat.
	Defective relief valve.	Replace with new relief valve.
Water on the floor/drain pan.	Water discharge from the relief valve.	See Pressure build-up in a water system.
	Element leaks.	Replace with new element.
	Water heater leaks.	Replace with new water heater.
Condensation.	Water heater filled for the first time.	Let water heater warm up. Problem should go away. If it persists, check all plumbing connections for leaks.
	Heavy draws of hot water with very cold refill water.	Let water heater warm up. Problem should go away. If it persists, check all plumbing connections for leaks.
	Water heater is undersized.	Install size of water heater that meets demand.
Wet insulation.	Leaking plumbing connections.	Locate leak and repair.
	Leaking around heating element.	Tighten, clean, and smooth face of tank flange and element gasket.
	Water discharge from the relief valve.	See Pressure build-up in a water system.
Singing element.	Build up of mineral deposits on element.	Clean element, replace with new element if necessary.
Singing thermostat.	Thermostat not flush with tank.	Install thermostat properly.
	Wiring connections are loose.	Locate, clean carefully, reconnect properly.
Traces of rust in the hot water.	Anode rods have been eaten away.	Replace with new anode rods.
Rusty water.	Water corrosion.	Replace with new water heater.
Rotten egg smell.	High sulphate or mineral content in water.	Change magnesium anodes to aluminum anodes and bleach water heater.
Tank bulged.	No relief valve installed.	Install proper relief valve.
	Excessive water pressure.	Install a pressure-reducing valve.
	Thermal expansion in a closed water system.	Install a suitable expansion tank on the cold water supply line.